

Article number: 2082277M1215B

Description: E+G Mini indexing plunger  
without rest position, GN 822.6-7-M12x1,5-B

## Measures

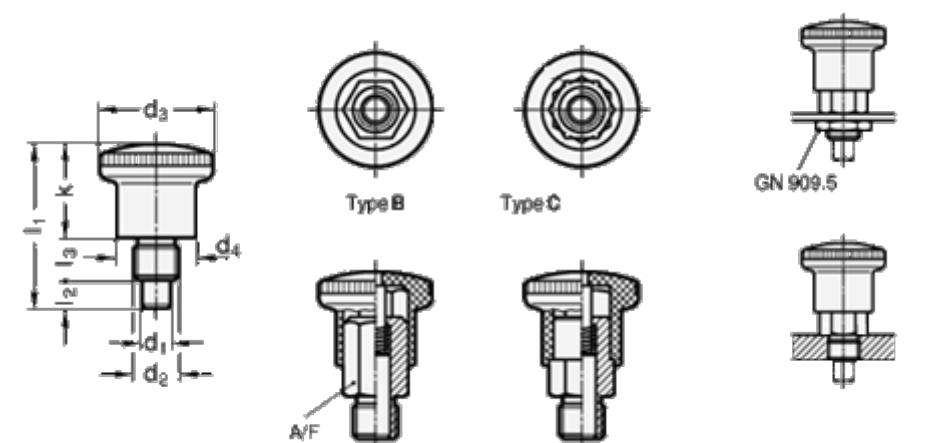

d1 = 7  
d2 = M12x1,5  
d3 = 28  
d4 = 20  
k = 23.5  
l1 = 40.5  
l2 = 7  
l3 = 10

Spring load initial N = 10